



# Thermal Monocular CONDOR Series

User Manual V5.5.70 202308



Contact Us

## Table of Contents

Chapter 1 Overview .....	1
1.1 Brief Description.....	1
1.2 Function.....	1
1.3 Appearance.....	1
Chapter 2 Preparation .....	1
2.1 Install Battery.....	1
2.1.1 Battery Instruction .....	1
2.1.2 Battery Installation .....	1
2.2 Cable Connection.....	2
2.3 Mount Hand Strap.....	3
2.4 Power On/Off.....	4
2.5 Menu Description .....	5
2.6 Client Software Connection.....	5
2.7 Firmware Status .....	6
2.7.1 Check Firmware Status.....	6
2.7.2 Upgrade Device .....	7
Chapter 3 Image Settings .....	9
3.1 Adjust Diopter .....	9
3.2 Adjust Focus.....	9
3.3 Adjust Brightness.....	10
3.4 Adjust Contrast .....	10
3.5 Adjust Tone.....	10
3.6 Adjust Sharpness .....	11
3.7 Select Scene .....	11
3.8 Set Palettes.....	12
3.9 Adjust Digital Zoom .....	13
3.10 Set Picture in Picture Mode.....	14
3.11 Flat Field Correction .....	14

# Thermal Monocular User Manual

---

3.12 Correct Defective Pixel .....	15
3.13 Image Pro.....	16
3.14 Zoom Pro .....	16
3.15 Auto Screen Off.....	17
<b>Chapter 4 Measure Distance with Laser .....</b>	<b>19</b>
<b>Chapter 5 General Settings .....</b>	<b>21</b>
5.1 Set OSD.....	21
5.2 Set Brand Logo.....	21
5.3 Burning Prevention .....	22
5.4 Capture and Video .....	22
5.4.1 Capture Picture .....	22
5.4.2 Set Audio.....	23
5.4.3 Record Video .....	23
5.5 Hot Tracking .....	23
5.6 Export Files .....	24
5.6.1 Export Files via HIKMICRO Sight.....	24
5.6.2 Export Files via PC.....	25
<b>Chapter 6 System Settings .....</b>	<b>27</b>
6.1 Adjust Date .....	27
6.2 Synchronize Time .....	27
6.3 Set Language.....	27
6.4 Set Unit .....	28
6.5 CVBS Output .....	28
6.6 View Device Information.....	29
6.7 Restore Device.....	29
<b>Chapter 7 Frequently Asked Questions .....</b>	<b>30</b>
7.1 Why does the charge indicator flash improperly?.....	30
7.2 Why is the power indicator off? .....	30
7.3 The image is not clear, how to adjust it? .....	30

# Thermal Monocular User Manual

---

7.4 Capturing or recording fails. What's the problem? .....	30
7.5 Why the PC cannot identify the device? .....	30
Safety Instruction .....	31
Legal Information .....	34
Regulatory Information .....	36

# Chapter 1 Overview

## 1.1 Brief Description

HIKMICRO CONDOR thermal monocular is equipped with an infrared detector and a 1024 × 768 OLED display. With less than 20 mK NETD, which represents high thermal sensitivity, it ensures image quality and detail recognition even in the hardest weather conditions. Its 1000 m laser rangefinder can accurately measure the distance when you are stalking in the forest or field or observing under low-light conditions. The device can be mainly applied in forest & field hunting, birding, animal searching, adventuring, and recusing scenario.

## 1.2 Function

### Zoom Pro

Zoom Pro, an advanced zoomed image processing algorithm, ensures maximum image optimization under digital zoom, especially from 1× to 2× and 4×.

### Distance Measurement

Built-in laser range finder provides an accurate distance between the target and the observation position.

### Auto Screen Off

Auto screen off function allows the device to enter standby mode/wake up through angle changes. The function darkens the screen to save energy and increase battery time.

### Client Software Connection

The device can capture snapshots, record videos, and set parameters by HIKMICRO Sight app after being connected to your phone via hotspot.

## 1.3 Appearance

The appearance may vary according to different models. Please take the actual product for reference.

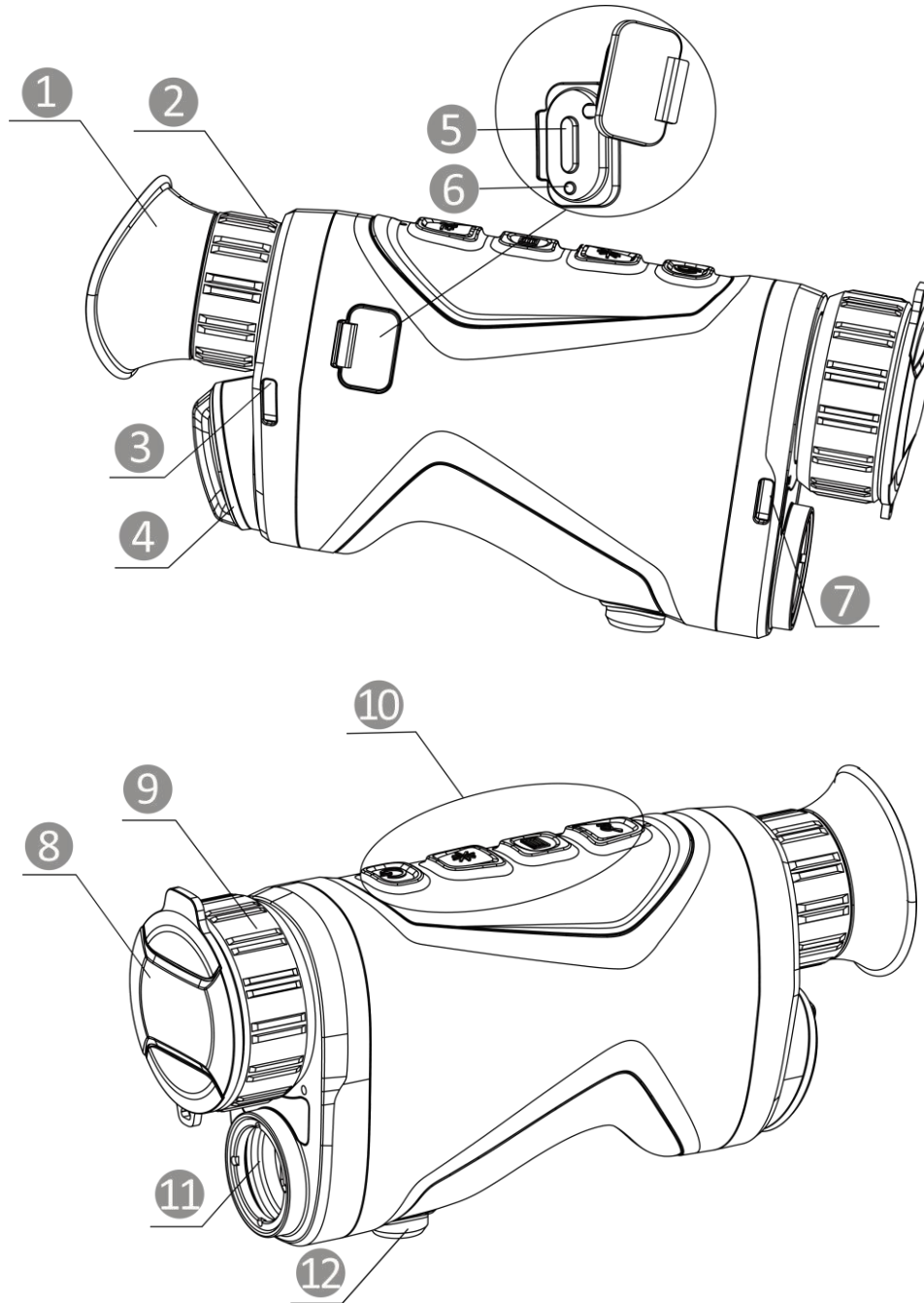

Figure 1-1 Appearance





Table 1-1 Components

No.	Description	Function
1	Eyepiece	The piece placed closest to the eye to view the target.
2	Diopter Adjustment Ring	Adjusts the dioptic setting.

## Thermal Monocular User Manual

3 & 7	Hand Strap Attachment Point	Mounts the hand strap.
4	Battery Compartment	For holding the battery.
5	Type-C Interface	To connect the device to power supply or to transmit data with a type-C cable.
6	Charging Status Indicator	<ul style="list-style-type: none"> <li>● Flashing Red &amp; Green: Error occurred.</li> <li>● Solid Red: Battery is charging.</li> <li>● Solid Green: Battery is fully charged.</li> </ul>
8	Lens Cover	Protects the lens from dust or scratch.
9	Focus Ring	Adjusts focus to obtain clear targets.
10	Buttons	To set functions and parameters.
11	Laser Rangefinder	Measures the distance to the target with laser.
12	Tripod Mount	Mounts the tripod.

**Table 1-2 Button Description**

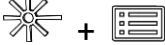
Icon	Button	Function
	Power	<ul style="list-style-type: none"> <li>● Press: Standby mode/Wake up device.</li> <li>● Hold: Power on/off.</li> </ul>
	Measure	Non-Menu Mode: <ul style="list-style-type: none"> <li>● Press: Turn on/off laser ranging.</li> <li>● Hold: Start/stop recording videos.</li> </ul> Menu Mode: Press to move up.
	Menu	Non-Menu Mode: <ul style="list-style-type: none"> <li>● Press: Switch palettes.</li> <li>● Hold: Enter the menu.</li> </ul> Menu Mode: <ul style="list-style-type: none"> <li>● Press: Confirm/set parameters.</li> <li>● Hold: Save and exit menu.</li> </ul>
	Zoom	Non-Menu Mode: <ul style="list-style-type: none"> <li>● Press: Switch digital zoom.</li> <li>● Hold: Correct non-uniformity of display (FFC).</li> </ul> Menu Mode: Press to move down.
	Measure + Menu	Press to capture snapshots.

### Note

When the auto screen off function is enabled, if you press  to enter standby mode, you can also tilt or rotate the device to wake up the device. Refer to *Auto Screen Off* for detailed operation.

---



## Chapter 2 Preparation

Take out the device and accessories. Check them with the packaging list to confirm device and accessories are included and available for use. Read the user manual to learn the usage methods and cautions.

### 2.1 Install Battery

#### 2.1.1 Battery Instruction

- The external rechargeable battery type is 18650, and the battery size should be 19 mm × 70 mm. The rated voltage and capacity are 3.6 VDC/3200 mAh.
- Remove the battery if the device is not used for a long time.
- Charge the battery for more than 4 hours before first use.

#### 2.1.2 Battery Installation

Insert the battery into the battery compartment.

##### Steps

1. Rotate the battery compartment cover counterclockwise (1) to loosen it, and pull the battery cover out (2).

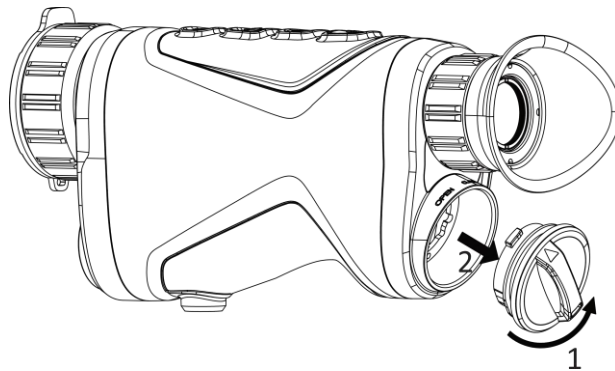
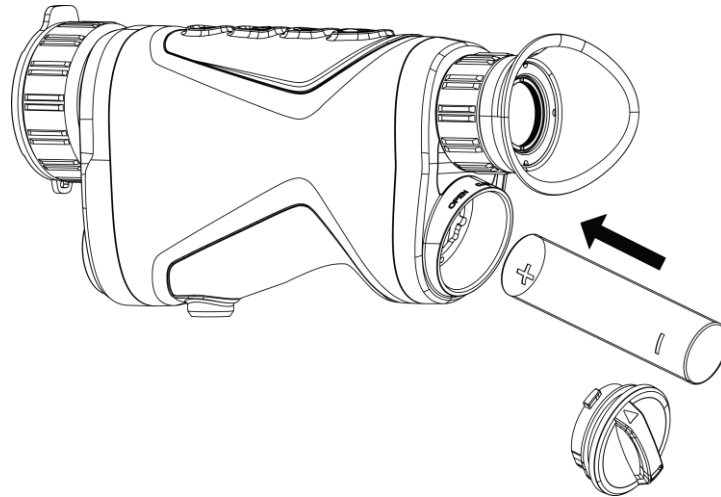

Figure 2-1 Loosen the Cover

2. Insert a battery into the battery compartment as the positive and negative marks indicate.



**Figure 2-2 Install the Battery**

3. Insert the battery compartment cover (3) and rotate it clockwise (4) until it is tight and locked.

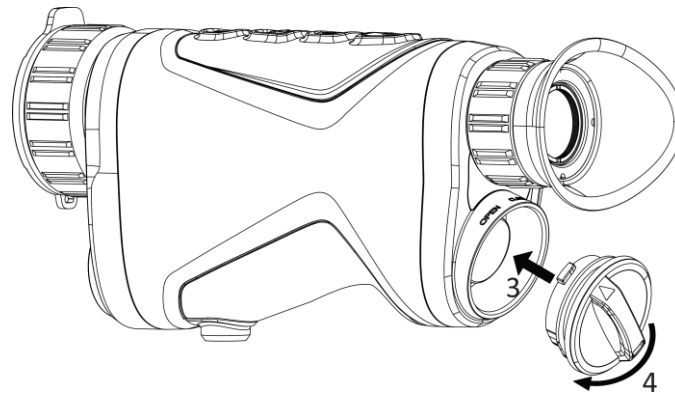

**Figure 2-3 Tighten the Cover**

## 2.2 Cable Connection

Connect the device and power adapter with a type-C cable to charge the device. Alternatively, connect the device and PC to export files.

### Steps

1. Lift the type-C interface cover.
2. Connect the device and power adapter with a type-C cable to charge the device.

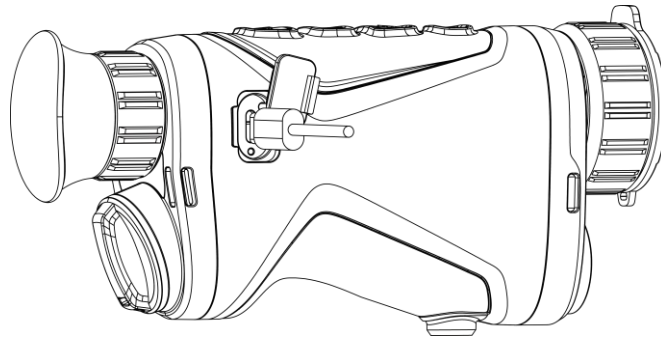

Figure 2-4 Cable Connection

---

**Note**

- Please charge the device after the battery is installed in the battery compartment of the device.
  - The charging temperature should be from 0 °C to 45 °C (32 °F to 113 °F).
- 

## 2.3 Mount Hand Strap

### Steps

1. Slide one end of the hand strap through the attachment point.

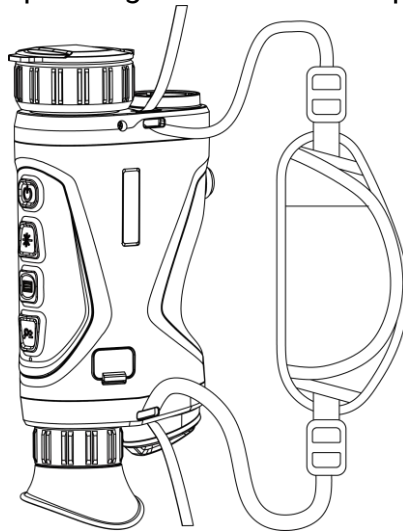

Figure 2-5 Thread Hand Strap through Attachment Point

2. Thread the hand strap through the hand strap buckle, and fasten the hand strap to secure it.

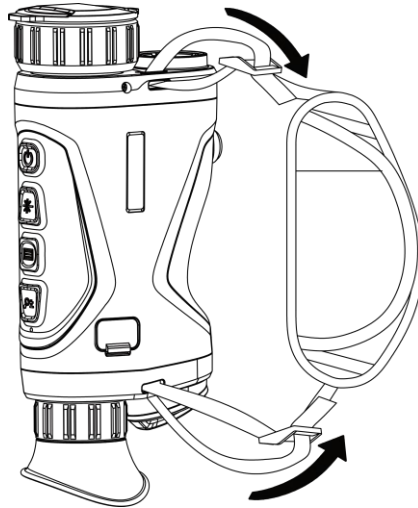



Figure 2-6 Secure Hand Strap

3. Repeat above steps to finish mounting.
4. Adjust the tightness of the hand strap as needed.

## 2.4 Power On/Off

### Power On

When the device is connected to cable or the battery is enough, hold  for 3 seconds to power on the device.

### Power Off

When the device is turned on, hold  for 3 seconds to power off the device.

---











#### Note

- Power-off countdown will appear when you power off the device. Do not release  when you power off the device, or the power-off will be canceled.
  - Automatic low battery power-off cannot be canceled.
- 

### Auto Power Off



You can set the auto power off time for your device.

#### Steps

1. Hold  to show the menu.
2. Go to  **Advanced Settings**, and select  **General Settings**.
3. Press  or  to select , and press  to enter the configuration interface.
4. Press  or  to select the auto power off time as required, and press  to confirm.

5. Hold  to save and exit.

## Note

- See the battery icon for the battery status.  means the battery is fully charged,  means that the battery is low, and  means the battery charging is abnormal.
  - When the low power note shows, charge the battery.
  - The auto power off countdown will start again when the device exits standby mode or the device is restarted.
- 

## 2.5 Menu Description

In the live view interface, hold  to show the menu.

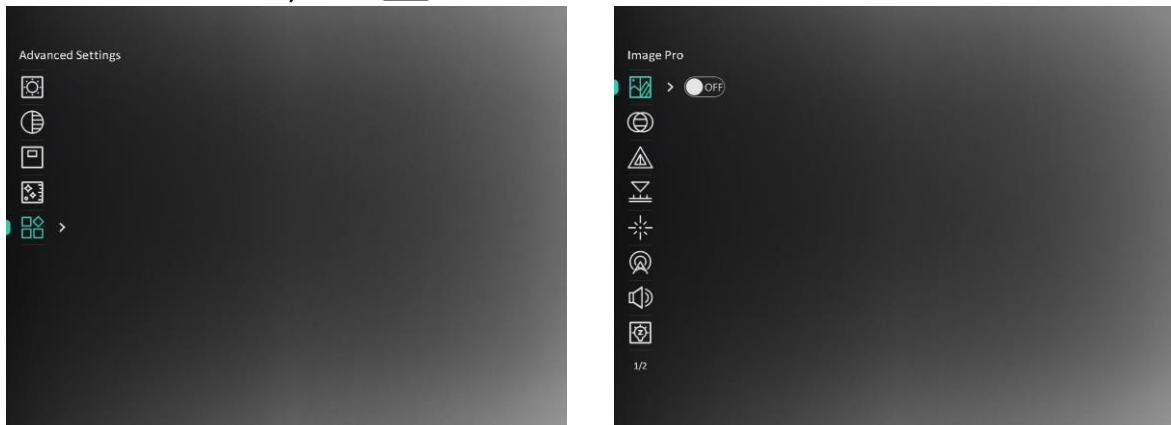





Figure 2-7 Menu Description

- Press  to move the cursor up.
- Press  to move the cursor down.
- Press  to confirm and hold it to exit the menu.

## 2.6 Client Software Connection

Connect the device to the HIKMICRO Sight app via hotspot, then you can capture picture, record video, or configure parameters on your phone.

### Steps









1. Search the HIKMICRO Sight on App Store (iOS System) or Google Play™ (Android System) to download it, or scan the QR code to download and install the app.



Android System



iOS System

2. Hold  to show the menu.
3. Go to  **Advanced Settings**, and press  or  to select .
4. Press  to enter the setting interface.
5. Press  or  to select **Hotspot**. The hotspot function is enabled.
6. Turn on the WLAN of your phone and connect to the hotspot.
  - Hotspot Name: HIKMICRO\_Serial No.
  - Hotspot Password: Serial No.
7. Open the app and connect your phone with the device. You can view the interface of device on your phone.

---

## Note

- The device cannot connect to the app if you enter wrong password several times. Refer to **Restore Device** to reset the device, and connect the app again.
  - The device should be activated for the first use. The default password must be changed after the activation.
  - Hotspot cannot be enabled when device battery is low.
- 

## 2.7 Firmware Status

### 2.7.1 Check Firmware Status

#### Steps

1. Open the HIKMICRO Sight and connect your device to the app.
2. Check if there is an upgrade prompt on the device management interface. If there is no upgrade prompt, the firmware is the latest version. Otherwise, the firmware is not the latest version.

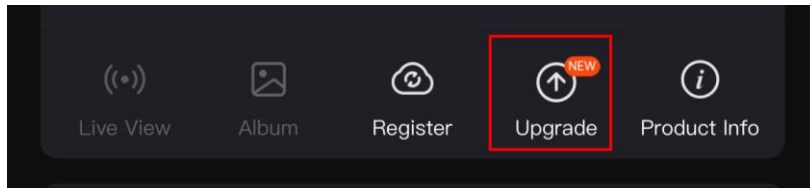

Figure 2-8 Check Firmware Status

3. (Optional) If the firmware is not the latest version, upgrade the device. See *Upgrade Device*.

## 2.7.2 Upgrade Device

### Upgrade Device via HIKMICRO Sight

#### Before You Start

Install HIKMICRO Sight on your phone and connect your device to the app.

#### Steps

1. Tap the upgrade prompt to enter the firmware upgrade interface.
2. Tap **Upgrade** to start upgrade.

---

#### Note

The upgrading operation may vary due to app updates. Please take the actual app version for reference.









---

### Upgrade Device via PC

#### Before You Start

Please get the upgrade package first.

#### Steps

1. Hold  to show the menu.
2. Go to  **Advanced Settings**, and select  **Function Settings**.
3. Press  or  to select , and press  to enter the configuration interface.
4. Press  or  to select **USB Flash Drive**.
5. Connect the device to your PC with cable.
6. Open the detected disk, copy the upgrade file and paste it to the root directory of the device.
7. Disconnect the device from your PC.
8. Reboot the device.

### **Result**

The device upgrades automatically. The upgrading process will be displayed in the interface.



## Chapter 3 Image Settings

You can set palettes, brightness, scenes, FFC (flat field correction), and DPC (defective pixel correction) to display the better image effect.

### 3.1 Adjust Diopter

Make sure the eyepiece covers your eye and aim at the target. Adjust the diopter adjustment ring until the OSD text or image is clear.

---

 **Note**

When adjusting diopter, DO NOT touch the surface of lens to avoid smearing the lens.

---

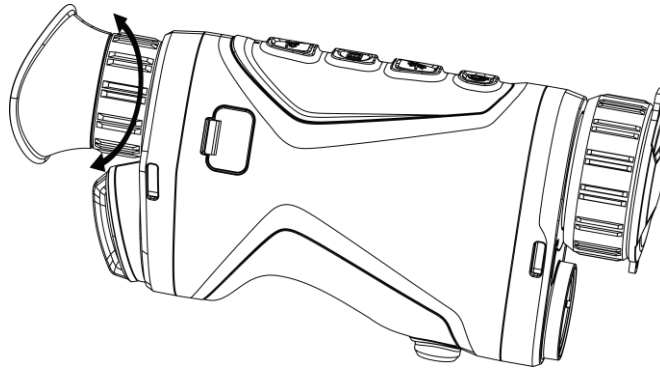

Figure 3-1 Adjust Diopter

### 3.2 Adjust Focus

Slightly rotate the focus ring to adjust the focus of the objective lens.

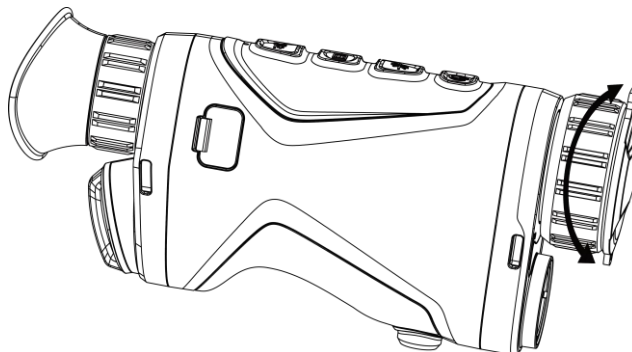

Figure 3-2 Adjust Objective Lens

## Note









DO NOT touch the lens directly with your finger, or place any sharp objects near them.

---

## 3.3 Adjust Brightness









You can adjust the display brightness of the screen in the menu.

### Steps

1. Hold  to show the menu.
2. Press  and  to select  and press  to confirm.
3. Press  and  to adjust display brightness.
4. Hold  to save settings and exit.









## 3.4 Adjust Contrast

### Steps

1. Hold  to show the menu.
2. Press  and  to select  and press  to confirm.
3. Press  or  to adjust contrast.
4. Hold  to save and exit.

## 3.5 Adjust Tone

### Steps

1. Hold  to show the menu.
2. Go to  **Advanced Settings**, and press  or  to select .
3. Press  to confirm, and press  or  to select a tone. **Warm** and **Cold** can be selected.
4. Hold  to save and exit.

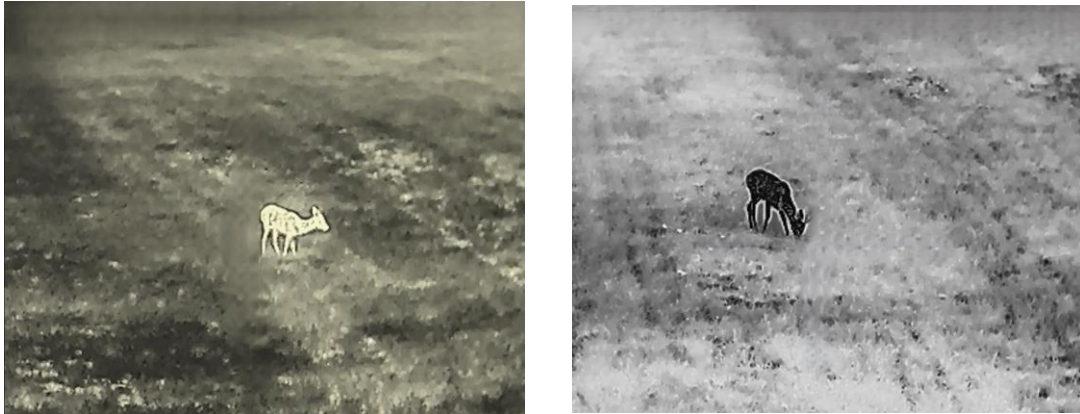











Figure 3-3 Adjust Tone

## 3.6 Adjust Sharpness

### Steps

1. Hold  to show the menu.
2. Go to  **Advanced Settings**, and press  or  to select .
3. Press  to confirm, and press  or  to adjust sharpness.
4. Hold  to save and exit.

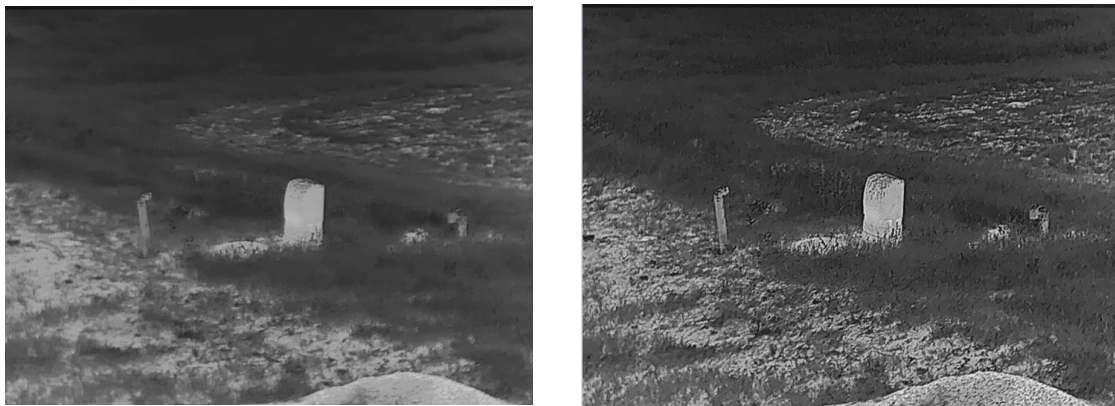











Figure 3-4 Sharpness Adjustment Comparison

## 3.7 Select Scene

You can select proper scene according to actual using scene to improve the display effect.

### Steps

1. Hold  to show the menu.
2. Go to  **Advanced Settings**, and press  or  to select .

3. Press  to enter the setting interface.
4. Press  or  to switch scene.
  - **Recognition:** Recognition refers to recognition mode and is recommended in normal scene.
  - **Jungle:** Jungle refers to jungle mode and is recommended in hunting environment.
5. Hold  to save settings and exit.

### 3.8 Set Palettes

You can select different palettes to display the same scene in different effects. Press  in the live view interface to switch palettes.

#### White Hot

The hot part is light-colored in view. The higher the temperature is, the lighter the color is.



#### Black Hot

The hot part is black-colored in view. The higher the temperature is, the darker the color is.



## Red Hot

The hot part is red-colored in view. The higher the temperature is, the redder the color is.



## Fusion

From high temperature to low temperature, the image is colored in from white, yellow, red, pink to purple.

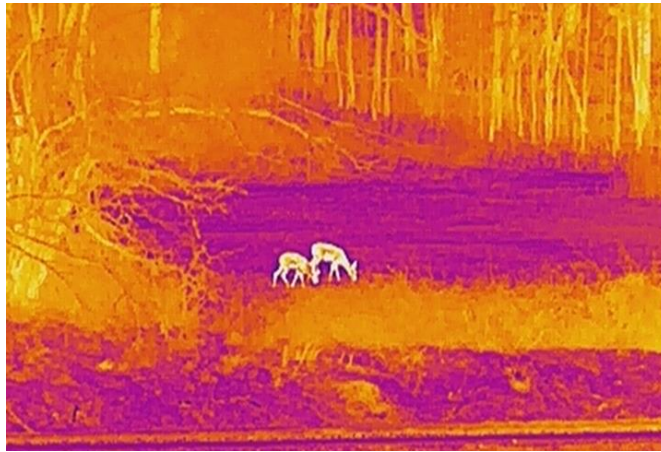

## 3.9 Adjust Digital Zoom

You can zoom in and out the image by using this function. Press  in the live view interface, the digital zoom ratio switches between 1×, 2×, 4× and 8×.

---

### Note

When switching the digital zoom ratio, the top-left corner of interface displays the actual magnification (Actual Magnification = Lens Optical Magnification × Digital Zoom Ratio). For example, the lens optical magnification is 2.8× and the digital zoom ratio is 2×, and the actual magnification is 5.6×.

---



## 3.10 Set Picture in Picture Mode

### Steps







1. Hold  to show the menu.
2. Press  and  to select .
3. Press  to enable or disable PIP mode. The details show in the upper center of the view.
4. Hold  to save the settings and exit.



Figure 3-5 Set Picture in Picture Mode

---

### Note











If the PIP function is enabled, only the PIP view zooms when adjusting the digital zoom ratio.

---

## 3.11 Flat Field Correction

This function can correct non-uniformity of display.

### Steps

1. Hold  to show the menu.
2. Go to  **Advanced Settings**, and select  **Function Settings**.
3. Press  or  to select , and press  to enter the configuration interface.
4. Press  or  to switch FFC mode.
  - **Manual FFC:** Hold  in the live view to correct the non-uniformity of display.
  - **Auto FFC:** The device performs FFC automatically according to the set schedule when

switching on the camera.

- **External:** Cover the lens cover, then hold  in the live view to correct the non-uniformity of display.

5. Hold  to save the settings and exit.

---

### Note













The countdown will start before the device performs FFC automatically.

---

## 3.12 Correct Defective Pixel

The device can correct the defective pixels on the screen which are not performed as expected.

### Steps

1. Hold  to show the menu.
  2. Go to  **Advanced Settings**, and select  **Function Settings**.
  3. Press  or  to select , and press  to enter DPC configuration interface.
  4. Press  to select **X** or **Y Axis**. If you select **X** axis, the cursor moves left and right; if you select **Y** axis, the cursor moves up and down.
  5. Press  or  to set the coordinates until the cursor reaches the defective pixel.
  6. Press  twice to correct the dead pixel.
  7. Hold  to save the settings and exit.
- 

### Note

- The selected defective pixel can be magnified and displayed on the bottom right of the interface.

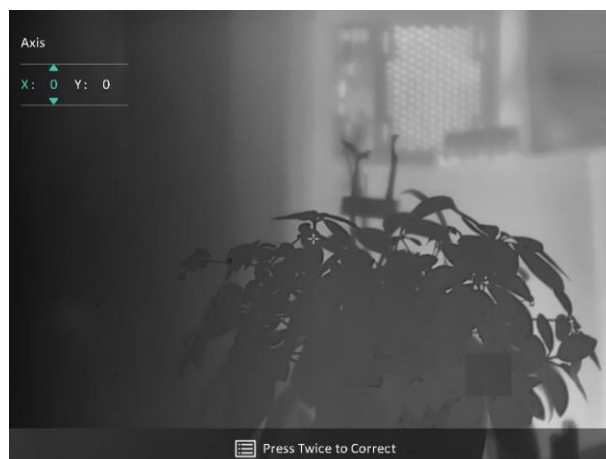

**Figure 3-6 Correct Defective Pixel**

- If the screen OSD blocks the defective pixel, move the cursor to reach the defective
-

pixel, then the device performs mirror display automatically as shown in the figures below.









Figure 3-7 Mirror Effect

---

## 3.13 Image Pro

Image pro refers to image detail enhancement. When you enable this function, the details of whole live view image will be enhanced.

### Steps

1. Hold  to show the menu.
2. Go to  **Advanced Settings**, and press  or  to select .
3. Press  to enable the function.
4. Hold  to save settings and exit.







### Result

The details of the whole live view image will be enhanced.

## 3.14 Zoom Pro

Zoom Pro refers to zoomed image detail enhancement. When you turn on this function, the details of zoomed live view image will be enhanced.

### Steps

1. Hold  to show the menu.
2. Press  and  to select .
3. Press  to enable the function.
4. Hold  to save settings and exit.



## Result

The details of the zoomed live view image will be enhanced.

---







## Note

- If the PIP function is enabled, zoom pro is only enabled in the PIP view.
  - Zoom Pro cannot be enabled when device battery is low.
- 

## 3.15 Auto Screen Off

Auto screen off function darkens the screen to save energy and increase battery time. However, the device stays on and you can view the live view on HIKMICRO Sight app when connecting the device to the app.

### Steps

1. Enable auto screen off.
  - 1). Hold  to show the menu.
  - 2). Go to  Advanced Settings, and press  or  to select .
  - 3). Press  to enable auto screen off.
  - 4). Hold  to save settings and exit.
2. You can do one of the following methods to enter the standby mode when the display is turned on:
  - Tilt the device downwards more than 70°.
  - Rotate the device horizontally more than 75°.
  - Keep the device still and do not move it for 5 minutes.

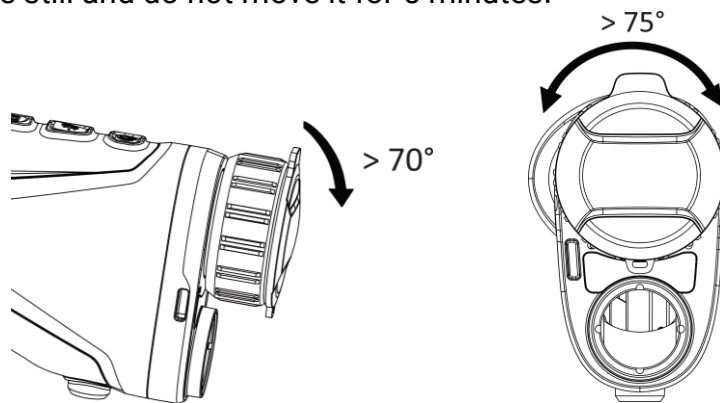

**Figure 3-8 Standby Mode**

3. You can do one of the following methods to wake up the device when the display is turned off:
  - Tilt the device downwards from 0° to 60° or upwards .
  - Rotate the device horizontally from 0° to 75°.
  - Press  to wake up the device.

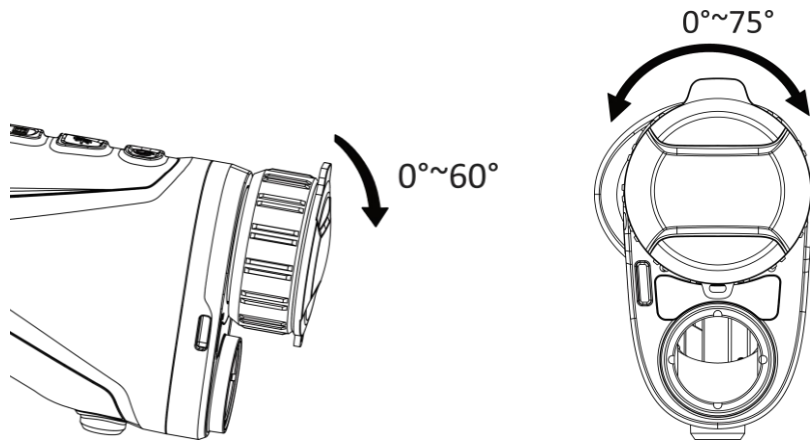

Figure 3-9 Wake up the Device











## Chapter 4 Measure Distance with Laser

The device can detect the distance between the target and the observation position with laser.

### Before You Start



When measuring the distance, keep the hand and the position steady. Otherwise, the accuracy may be affected.

### Steps

1. Hold  to show the menu.
2. Go to  **Advanced Settings**, and press  or  to select .
3. Press  to go to the measurement interface.
4. Press  or  to select a continuous laser ranging mode. Press  to confirm.  
The device can measure the distance continuously, and the measurement duration can be selected. The measurement result will be refreshed every 1 s.
- 5 Hold  to save the setting and return to the live view interface.
6. Aim the cursor at the target and press  to measure the target distance.

---

### Note

- Press  in the live view interface to enable laser ranging, and press  again in the live view interface to turn off laser ranging.
  - Laser ranging cannot be enabled when device battery is low.
- 

### Result

The distance measurement result is displayed at the upper right of the image.

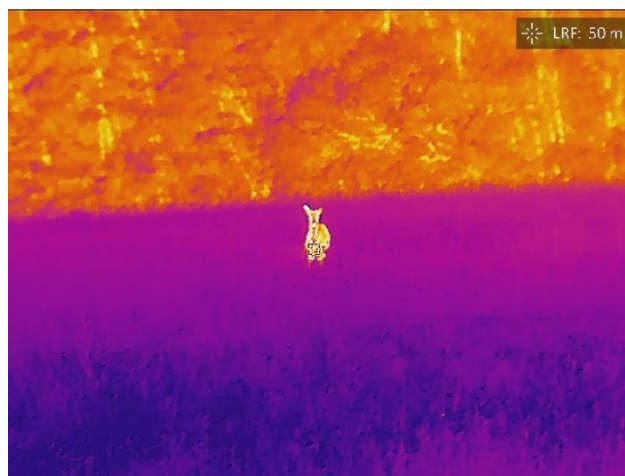

Figure 4-1 Laser Ranging Result

 **Caution**

The laser radiation emitted from the device can cause eye injuries, burning of skin or inflammable substances. Before enabling the laser ranging function, make sure no human or inflammable substances are in front of the laser lens.











---

## Chapter 5 General Settings

### 5.1 Set OSD

This function can display or hide the OSD information on the live view interface.

#### Steps

1. Hold  to show the menu.
2. Go to  **Advanced Settings**, and select  **Function Settings**.
3. Press  or  to select **OSD** , and press  to enter OSD setting interface.
4. Press  or  to select the **Time, Date, or OSD**, and press  to turn on or turn off the selected OSD information.
5. Hold  to save and exit.

---

#### Note









If you turn off **OSD**, all OSD information on the live view will not be displayed.

---

### 5.2 Set Brand Logo

You can add brand logo to the live view interface, snapshots, and videos.

#### Steps

1. Hold  to show the menu.
2. Go to  **Advanced Settings**, and select  **Function Settings**.
3. Press  or  to select  .
4. Press  to enable **Brand Logo**.
5. Hold  to save the settings and exit.

#### Result

The brand logo is displayed at the bottom left of the image.

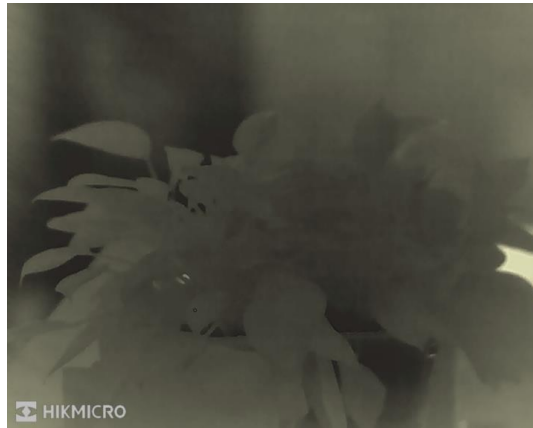









Figure 5-1 Brand Logo Display

## 5.3 Burning Prevention

Avoid direct sunlight and enable the burning prevention function to reduce the risk of sensor damage from the heat.

### Steps

1. Hold  to show the menu.
2. Go to  **Advanced Settings**, and select  **Function Settings**.
3. Press  or  to select .
4. Press  to enable or disable the burn-prevention function.
5. Hold  to save settings and exit.

## 5.4 Capture and Video

### 5.4.1 Capture Picture

In the live view interface, press  +  to capture picture.

---

#### Note

When capturing succeeds, the image freezes for 1 second and a prompt shows on the display.







For exporting pictures, refer to *Export Files*.

---

## 5.4.2 Set Audio

If you turn on the audio function, the sound will be recorded with the video. When there is too loud noise in the video, you can turn off this function.

### Steps

1. Hold  to show the menu.
2. Go to  **Advanced Settings**, and press  or  to select .
3. Press  to enable or disable this function.
4. Hold  to save settings and exit.

## 5.4.3 Record Video

### Steps

1. In the live view interface, hold  to start recording.



**Figure 5-2 Start Recording**

The left top of image displays the information of recording time.

2. Hold  again to stop recording.

### What to do next





For exporting videos, refer to *Export Files*.

## 5.5 Hot Tracking

The device can detect the highest temperature spot in the scene and mark it on display.

### Steps

1. Hold  to show the menu.

2. Go to  **Advanced Settings**, and press  or  to select .
3. Press  to mark the spot of highest temperature.

## Result



When the function is enabled,  displays in the spot of highest temperature. When the scene changes, the  moves.



Figure 5-3 Hot Tracking

## 5.6 Export Files

### 5.6.1 Export Files via HIKMICRO Sight

You can access device albums and export files to your phone via HIKMICRO Sight.

#### Before You Start

Install HIKMICRO Sight on your mobile phone.

#### Steps

1. Open HIKMICRO Sight and connect your device to the app. See *Client Software Connection*.
2. Tap **Media** to access device albums.

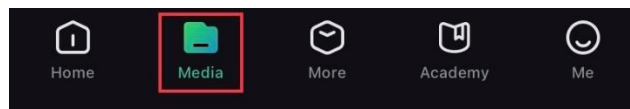

Figure 5-4 Access Device Albums

3. Tap **Local** or **Device** to view the photos and videos.
  - **Local**: You can view the files captured on app.
  - **Device**: You can view the files of the current device.



## Note

The photos or videos may not show in **Device**. Please pull down to refresh the page.

---

4. Tap to select a file, and tap **Download** to export the file to your local phone albums.



Figure 5-5 Export Files

---

## Note

- Go to **Me -> About -> User Manual** on the app to see more detailed operations.
- You can also access device albums by tapping bottom left icon in the live view interface.

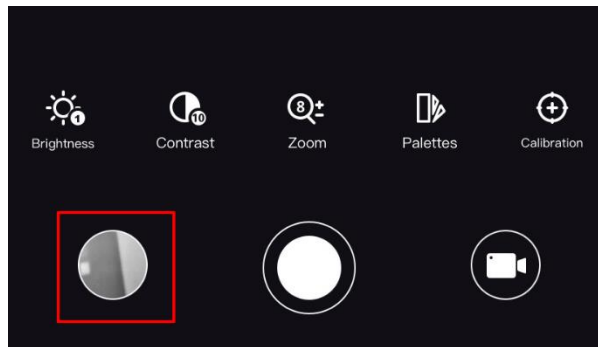











Figure 5-6 Access Device Albums

- The exporting operation may vary due to app updates. Please take the actual app version for reference.
- 

## 5.6.2 Export Files via PC

This function is used to export recorded videos and captured pictures.

### Steps

1. Hold  to show the menu.
2. Go to  **Advanced Settings**, and select  **Function Settings**.
3. Press  or  to select , and press  to enter the configuration interface.
4. Press  or  select **USB Flash Drive**.
5. Connect the device and PC with cable.

---

### Note

Make sure the device is turned on when connecting the cable.

---

6. Open computer disk and select the disk of device. Go to the DCIM folder and find the folder named after the capture year and month. For example, if you capture a picture or record a video on June 2023, go to **DCIM -> 202306** to find the picture or video.
  7. Select and copy the files to PC.
  8. Disconnect the device from your PC.
- 











### Note

- The device displays images when you connect it to PC. But functions such as recording, capturing and hotspot are disabled.
  - When you connect the device to PC for the first time, it installs the drive program automatically.
-

## Chapter 6 System Settings















### 6.1 Adjust Date

#### Steps

1. Hold  to show the menu.
2. Go to  **Advanced Settings**, and select  **General Settings**.
3. Press  or  to select .
4. Press  to enter the configuration interface.
5. Press  to select the year, month, or day, and press  or  to change the number.
6. Hold  to save settings and exit.

### 6.2 Synchronize Time



#### Steps









1. Hold  to show the menu.
2. Go to  **Advanced Settings**, and select  **General Settings**.
3. Press  or  to select .
4. Press  to enter the configuration interface.
5. Press  to switch the clock system. 24-hour and 12-hour clock are selectable. If you select 12-hour clock, press , and then press  or  to select AM or PM.
6. Press  to select the hour or minute, and press  or  to change the number.
7. Hold  to save settings and exit.

### 6.3 Set Language

You can select the device language in this function.

#### Steps











1. Hold  to show the menu.
2. Go to  **Advanced Settings**, and select  **General Settings**.

3. Press  or  to select .
4. Press  to enter the language configuration interface.
5. Press  or  to select the language as required, and press  to confirm.
6. Hold  to save settings and exit.

## 6.4 Set Unit

You can switch the unit for distance measurement.

### Steps

1. Hold  to show the menu.
2. Go to  **Advanced Settings**, and select  **General Settings**.
3. Press  or  to select .
4. Press  to enter the unit setting interface. Press  or  to select the unit as required.
5. Hold  to save settings and exit.











## 6.5 CVBS Output

The CVBS output is used to debug the device. You can also view the device image on the display or handheld screen for details.

### Before You Start

Connect the device and the display unit via USB to CVBS cable.

### Steps

1. Hold  to show the menu.
2. Go to  **Advanced Settings**, and select  **Function Settings**.
3. Press  or  to select .
4. Press  to enter the configuration interface.
5. Press  or  select **Analog** to turn on CVBS output.
6. Hold  to save settings and exit.

---









### Note

The CVBS cable is not included in the package. Please purchase it by yourself.

---







## 6.6 View Device Information

### Steps

1. Hold  to show the menu.
2. Go to  **Advanced Settings**, and select  **General Settings**.
3. Press  or  to select .
4. Press  to confirm. You can view the device information such as version and serial No.
5. Hold  to save settings and exit.

## 6.7 Restore Device

### Steps

1. Hold  to show the menu.
2. Go to  **Advanced Settings**, and select  **General Settings**.
3. Press  or  to select .
4. Press  to restore the device to defaults according to the prompt.

## Chapter 7 Frequently Asked Questions

### 7.1 Why does the charge indicator flash improperly?

Check the following items.

- Check whether the device is charged with standard power adapter and the charging temperature is above 0 °C (32 °F).
- The device is equipped with built-in charging protection module. Charge the device in power off status.

### 7.2 Why is the power indicator off?

Check whether the device is off-battery. Check the indicator after charging the device for 5 minutes.

### 7.3 The image is not clear, how to adjust it?

Adjust the diopter adjustment ring or focus ring until the image is clear. Refer to *Adjust Diopter* or *Adjust Focus*.

### 7.4 Capturing or recording fails. What's the problem?

Check the following items.

- Whether the device is connected to your PC. Capturing or recording is disabled in this status.
- Whether the storage space is full.
- Whether the device is low-battery.

### 7.5 Why the PC cannot identify the device?

Check the following items.

- Whether the device is connected to your PC with supplied USB cable.
- If you use other USB cables, make sure the cable length is no longer than 1 m.

## Safety Instruction



These instructions are intended to ensure that user can use the product correctly to avoid danger or property loss.

### Laws and Regulations

- Use of the product must be in strict compliance with the local electrical safety regulations.

### Symbol Conventions

The symbols that may be found in this document are defined as follows.

Symbol	Description
 <b>Danger</b>	Indicates a hazardous situation which, if not avoided, will or could result in death or serious injury.
 <b>Caution</b>	Indicates a potentially hazardous situation which, if not avoided, could result in equipment damage, data loss, performance degradation, or unexpected results.
 <b>Note</b>	Provides additional information to emphasize or supplement important points of the main text.

### Transportation

- Keep the device in original or similar packaging while transporting it.
- Keep all wrappers after unpacking them for future use. In case of any failure occurred, you need to return the device to the factory with the original wrapper. Transportation without the original wrapper may result in damage on the device and the company shall not take any responsibilities.
- Do not drop the product or subject it to physical shock. Keep the device away from magnetic interference.

### Power Supply

- Input voltage should meet the Limited Power Source (5 VDC, 2 A) according to the IEC61010-1 standard. Please refer to technical specifications for detailed information.
- Make sure the plug is properly connected to the power socket.
- DO NOT connect multiple devices to one power adapter, to avoid over-heating or fire hazards caused by overload.

### Battery

- The external rechargeable battery type is 18650, and the battery size should be 19 mm ×

70 mm. The rated voltage and capacity are 3.6 VDC/3200 mAh.

- For long-term storage of the battery, make sure it is fully charged every half year to ensure the battery quality. Otherwise, damage may occur.
- Use the battery provided by qualified manufacturer. Refer to the product specification for detailed battery requirements.
- CAUTION: Risk of explosion if the battery is replaced by an incorrect type.
- Improper replacement of the battery with an incorrect type may defeat a safeguard (for example, in the case of some lithium battery types).
- Do not dispose of the battery into fire or a hot oven, or mechanically crush or cut the battery, which may result in an explosion.
- Do not leave the battery in an extremely high temperature surrounding environment, which may result in an explosion or the leakage of flammable liquid or gas.
- Do not subject the battery to extremely low air pressure, which may result in an explosion or the leakage of flammable liquid or gas.
- Dispose of used batteries according to the instructions.

### Maintenance

- If the product does not work properly, please contact your dealer or the nearest service center. We shall not assume any responsibility for problems caused by unauthorized repair or maintenance.
- Wipe the device gently with a clean cloth and a small quantity of ethanol, if necessary.
- If the equipment is used in a manner not specified by the manufacturer, the protection provided by the device may be impaired.

### Using Environment

- Make sure the running environment meets the requirement of the device. The operating temperature shall be -30 °C to 55 °C (-22 °F to 131 °F), and the operating humidity shall be from 5% to 95%.
- DO NOT expose the device to high electromagnetic radiation or dusty environments.
- DO NOT aim the lens at the sun or any other bright light.

### Maintenance

- If the product does not work properly, please contact your dealer or the nearest service center. We shall not assume any responsibility for problems caused by unauthorized repair or maintenance.
- Wipe the device gently with a clean cloth and a small quantity of ethanol, if necessary.
- If the equipment is used in a manner not specified by the manufacturer, the protection provided by the device may be impaired.

### Emergency

- If smoke, odor, or noise arises from the device, immediately turn off the power, unplug



the power cable, and contact the service center.

### Laser

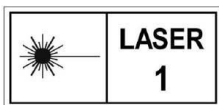

When any laser equipment is in use, make sure that the device lens is not exposed to the laser beam, or it may burn out. The laser radiation emitted from the device can cause eye injuries, burning of skin or inflammable substances. Before enabling the laser ranging function, make sure no human or inflammable substances are in front of the laser lens. Do not place the device where minors can fetch it. The wavelength is 905 nm, and the max. power output is less than 1 mW. According to IEC 60825-1:2014, this laser product is classified as Class 1 laser product.

### Manufacture Address

Room 313, Unit B, Building 2, 399 Danfeng Road, Xixing Subdistrict, Binjiang District,  
Hangzhou, Zhejiang 310052, China  
Hangzhou Microimage Software Co., Ltd.

COMPLIANCE NOTICE: The thermal series products might be subject to export controls in various countries or regions, including without limitation, the United States, European Union, United Kingdom and/or other member countries of the Wassenaar Arrangement. Please consult your professional legal or compliance expert or local government authorities for any necessary export license requirements if you intend to transfer, export, re-export the thermal series products between different countries.

## Legal Information

©2023 Hangzhou Microimage Software Co., Ltd. All rights reserved.

### About this Manual

The Manual includes instructions for using and managing the Product. Pictures, charts, images and all other information hereinafter are for description and explanation only. The information contained in the Manual is subject to change, without notice, due to firmware updates or other reasons. Please find the latest version of this Manual at the HIKMICRO website ([www.hikmicrotech.com](http://www.hikmicrotech.com)).

Please use this Manual with the guidance and assistance of professionals trained in supporting the Product.

### Trademarks Acknowledgement



and other HIKMICRO's trademarks and logos are the properties of HIKMICRO in various jurisdictions.

Other trademarks and logos mentioned are the properties of their respective owners.

### LEGAL DISCLAIMER

TO THE MAXIMUM EXTENT PERMITTED BY APPLICABLE LAW, THIS MANUAL AND THE PRODUCT DESCRIBED, WITH ITS HARDWARE, SOFTWARE AND FIRMWARE, ARE PROVIDED "AS IS" AND "WITH ALL FAULTS AND ERRORS". HIKMICRO MAKES NO WARRANTIES, EXPRESS OR IMPLIED, INCLUDING WITHOUT LIMITATION, MERCHANTABILITY, SATISFACTORY QUALITY, OR FITNESS FOR A PARTICULAR PURPOSE. THE USE OF THE PRODUCT BY YOU IS AT YOUR OWN RISK. IN NO EVENT WILL HIKMICRO BE LIABLE TO YOU FOR ANY SPECIAL, CONSEQUENTIAL, INCIDENTAL, OR INDIRECT DAMAGES, INCLUDING, AMONG OTHERS, DAMAGES FOR LOSS OF BUSINESS PROFITS, BUSINESS INTERRUPTION, OR LOSS OF DATA, CORRUPTION OF SYSTEMS, OR LOSS OF DOCUMENTATION, WHETHER BASED ON BREACH OF CONTRACT, TORT (INCLUDING NEGLIGENCE), PRODUCT LIABILITY, OR OTHERWISE, IN CONNECTION WITH THE USE OF THE PRODUCT, EVEN IF HIKMICRO HAS BEEN ADVISED OF THE POSSIBILITY OF SUCH DAMAGES OR LOSS.

YOU ACKNOWLEDGE THAT THE NATURE OF THE INTERNET PROVIDES FOR INHERENT SECURITY RISKS, AND HIKMICRO SHALL NOT TAKE ANY RESPONSIBILITIES FOR ABNORMAL OPERATION, PRIVACY LEAKAGE OR OTHER DAMAGES RESULTING FROM CYBER-ATTACK, HACKER ATTACK, VIRUS INFECTION, OR OTHER INTERNET SECURITY RISKS; HOWEVER, HIKMICRO WILL PROVIDE TIMELY TECHNICAL SUPPORT IF REQUIRED. YOU AGREE TO USE THIS PRODUCT IN COMPLIANCE WITH ALL APPLICABLE LAWS, AND YOU ARE SOLELY RESPONSIBLE FOR ENSURING THAT YOUR USE CONFORMS TO THE APPLICABLE LAW. ESPECIALLY, YOU ARE RESPONSIBLE, FOR USING THIS PRODUCT IN A MANNER THAT DOES NOT INFRINGE ON THE RIGHTS OF THIRD PARTIES, INCLUDING

## Thermal Monocular User Manual

---

WITHOUT LIMITATION, RIGHTS OF PUBLICITY, INTELLECTUAL PROPERTY RIGHTS, OR DATA PROTECTION AND OTHER PRIVACY RIGHTS. YOU SHALL NOT USE THIS PRODUCT FOR ILLEGAL HUNTING ANIMALS, INVASION OF PRIVACY OR ANY OTHER PURPOSE WHICH IS ILLEGAL OR DETRIMENTAL TO THE PUBLIC INTEREST. YOU SHALL NOT USE THIS PRODUCT FOR ANY PROHIBITED END-USES, INCLUDING THE DEVELOPMENT OR PRODUCTION OF WEAPONS OF MASS DESTRUCTION, THE DEVELOPMENT OR PRODUCTION OF CHEMICAL OR BIOLOGICAL WEAPONS, ANY ACTIVITIES IN THE CONTEXT RELATED TO ANY NUCLEAR EXPLOSIVE OR UNSAFE NUCLEAR FUEL-CYCLE, OR IN SUPPORT OF HUMAN RIGHTS ABUSES.

IN THE EVENT OF ANY CONFLICTS BETWEEN THIS MANUAL AND THE APPLICABLE LAW, THE LATTER PREVAILS.

## Regulatory Information

---

These clauses apply only to the products bearing the corresponding mark or information.

---

### EU/UK Compliance Statement



This product and - if applicable - the supplied accessories too are marked with "CE" and comply therefore with the applicable harmonized European standards listed under the Directive 2014/30/EU (EMCD), Directive 2014/35/EU (LVD), Directive 2011/65/EU (RoHS), Directive 2014/53/EU.



This product and - if applicable - the supplied accessories too are marked with "UKCA" and comply therefore with the following directives: Radio Equipment Regulations 2017, Electromagnetic Compatibility Regulations 2016, Electrical Equipment (Safety) Regulations 2016, the Restriction of the Use of Certain Hazardous Substances in Electrical and Electronic Equipment Regulations 2012.

#### Frequency Bands and Power (for CE/UKCA)

The frequency bands and transmitting power (radiated and/or conducted) nominal limits applicable to the following radio equipment are as follows:

Wi-Fi 2.4 GHz (2.4 GHz to 2.4835 GHz), 20 dBm

For the device without a supplied power adapter, use the power adapter provided by a qualified manufacturer. Refer to the product specification for detailed power requirements.

For the device without a supplied battery, use the battery provided by a qualified manufacturer. Refer to the product specification for detailed battery requirements.



Directive 2012/19/EU (WEEE Directive): Products marked with this symbol cannot be disposed of as unsorted municipal waste in the European Union. For proper recycling, return this product to your local supplier upon the purchase of equivalent new equipment, or dispose of it at designated collection points. For more information see: [www.recyclethis.info](http://www.recyclethis.info)

According to the Waste Electrical and Electronic Equipment Regulations 2013: Products marked with this symbol cannot be disposed of as

unsorted municipal waste in the United Kingdom. For proper recycling, return this product to your local supplier upon the purchase of equivalent new equipment, or dispose of it at designated collection points. For more information see: [www.recyclethis.info](http://www.recyclethis.info).



Directive 2006/66/EC and its amendment 2013/56/EU (Battery Directive): This product contains a battery that cannot be disposed of as unsorted municipal waste in the European Union. See the product documentation for specific battery information. The battery is marked with this symbol, which may include lettering to indicate cadmium (Cd), lead (Pb), or mercury (Hg). For proper recycling, return the battery to your supplier or to a designated collection point. For more information see: [www.recyclethis.info](http://www.recyclethis.info).

According to the Batteries and Accumulators (Placing on the Market) Regulations 2008 and the Waste Batteries and Accumulators Regulations 2009: This product contains a battery that cannot be disposed of as unsorted municipal waste in the United Kingdom. See the product documentation for specific battery information. The battery is marked with this symbol, which may include lettering to indicate cadmium (Cd), lead (Pb), or mercury (Hg). For proper recycling, return the battery to your supplier or to a designated collection point. For more information see: [www.recyclethis.info](http://www.recyclethis.info).

### Industry Canada ICES-003 Compliance

This device meets the CAN ICES-003 (B)/NMB-003(B) standards requirements. This device complies with Industry Canada license-exempt RSS standard(s). Operation is subject to the following two conditions:

- (1) this device may not cause interference, and
- (2) this device must accept any interference, including interference that may cause undesired operation of the device.

This equipment complies with IC RSS-102 radiation exposure limits set forth for an uncontrolled environment.

### Conformité Industrie Canada ICES-003

Cet appareil répond aux exigences des normes CAN ICES-003 (B)/NMB-003 (B). Cet appareil est conforme aux normes RSS exemptes de licence d'Industrie Canada. Son fonctionnement est soumis aux deux conditions suivantes :

- (1) cet appareil ne doit pas causer d'interférences, et
- (2) cet appareil doit accepter toute interférence reçue, notamment les interférences susceptibles d'occasionner un fonctionnement indésirable de l'appareil.

Cet appareil est conforme aux limites d'exposition au rayonnement IC RSS-102 établies pour un environnement non contrôlé.

### **KC**

B급 기기: 이 기기는 가정용(B급) 전자파적합기기로서 주로 가정에서 사용하는 것을 목적으로 하며, 모든 지역에서 사용할 수 있습니다.



**HIKMICRO**

See the World in a New Way



Facebook: HIKMICRO Outdoor Instagram: hikmicro\_outdoor

YouTube: HIKMICRO Outdoor

LinkedIn: HIKMICRO

Web: [www.hikmicrotech.com](http://www.hikmicrotech.com)

E-mail: [support@hikmicrotech.com](mailto:support@hikmicrotech.com)

UD34293B